

GENERAL NOTES:

- ALL DIMENSIONS ARE IN MILLIMETERS. LEVELS ARE IN METERS UNLESS NOTED OTHERWISE.
- ONLY FIGURED DIMENSIONS TO BE FOLLOWED. SCALED DIMENSIONS OF DRAWINGS WILL NOT BE PERMITTED.
- THIS DRAWING SHOULD BE READ IN CONJUNCTION WITH OTHER RELEVANT ARCHITECTURAL, STRUCTURAL, MECHANICAL & ELECTRICAL DRAWINGS AND SECTIONS OF THE SPECIFICATIONS.
- CONCRETE GRADE FCU = 40N/MM² & STEEL GRADE = 460N/MM²
- LAP & ANCHORAGE = 50x BAR DIAMETER

LAP & Ld SCHEDULE	BAR SIZE	VALUE
T10	500	
T12	600	
T16	800	
T20	1000	
T25	1250	
T32	1600	

- COVER:**
COLUMN ALL SIDE - 30mm
- LEGEND:**
 B1 - BOTTOM FIRST LAYER
 B2 - BOTTOM SECOND LAYER
 T1 - TOP FIRST LAYER
 T2 - TOP SECOND LAYER
 V - VERTICAL BAR
 SSL - STRUCTURAL SLAB LEVEL
 ES - EACH SIDE
 ADDL - ADDITIONAL
 ALT - ALTERNATE
 EF - EACH FACE
 ~~~ - CONSTRUCTION JOINT

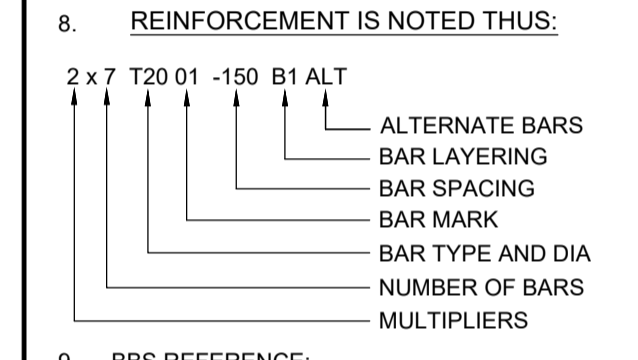

- BBS REFERENCE:**  
OPI-CSI-A126-SHD-ST-040

| SHOP DRAWING/SUBMITTAL REVIEW                            |                                                                   |
|----------------------------------------------------------|-------------------------------------------------------------------|
| <input type="checkbox"/> STATUS A - APPROVED             | <input type="checkbox"/> STATUS B - APPROVED WITH CHANGES / NOTES |
| <input type="checkbox"/> STATUS C - REVISED AND RESUBMIT | <input type="checkbox"/> STATUS D - REJECTED                      |

SUBMITTAL WAS REVIEWED FOR DESIGN CONFORMITY, SPECIFICATION AND GENERAL CONFORMITY IN ACCORDANCE TO CONTRACT DOCUMENTS.

COMMENTS: .....

BY: ..... DATE: .....

| No. | Date       | MRR | By | ISSUED FOR APPROVAL | Revision Details |
|-----|------------|-----|----|---------------------|------------------|
| 00  | 13.09.2024 | MRR |    | ISSUED FOR APPROVAL |                  |

CLIENT: FEEL FREE CREATION

PROJECT: SAMPLE PROJECT

CONSULTANT: DYN DIGI

MAIN CONTRACTOR:

SUB CONTRACTOR: DYN DIGI Engineering Services

98, Swamy Nagar, Vinayachandrapuram, Vellore, Tamil Nadu, India.  
 Telephone : +91 9556671043  
 Web : www.dyndigi.com  
 E-mail : info@dyndigi.com

DRAWING TITLE: STARTERS SAMPLE DRAWING-1

|                 |                |                 |
|-----------------|----------------|-----------------|
| Drawn by MRR    | Checked by FFC | Approved by SUN |
| Date 13-09-2024 | Scale A1=1:50  | Revision 00     |

Drawing No. STARTERS-1

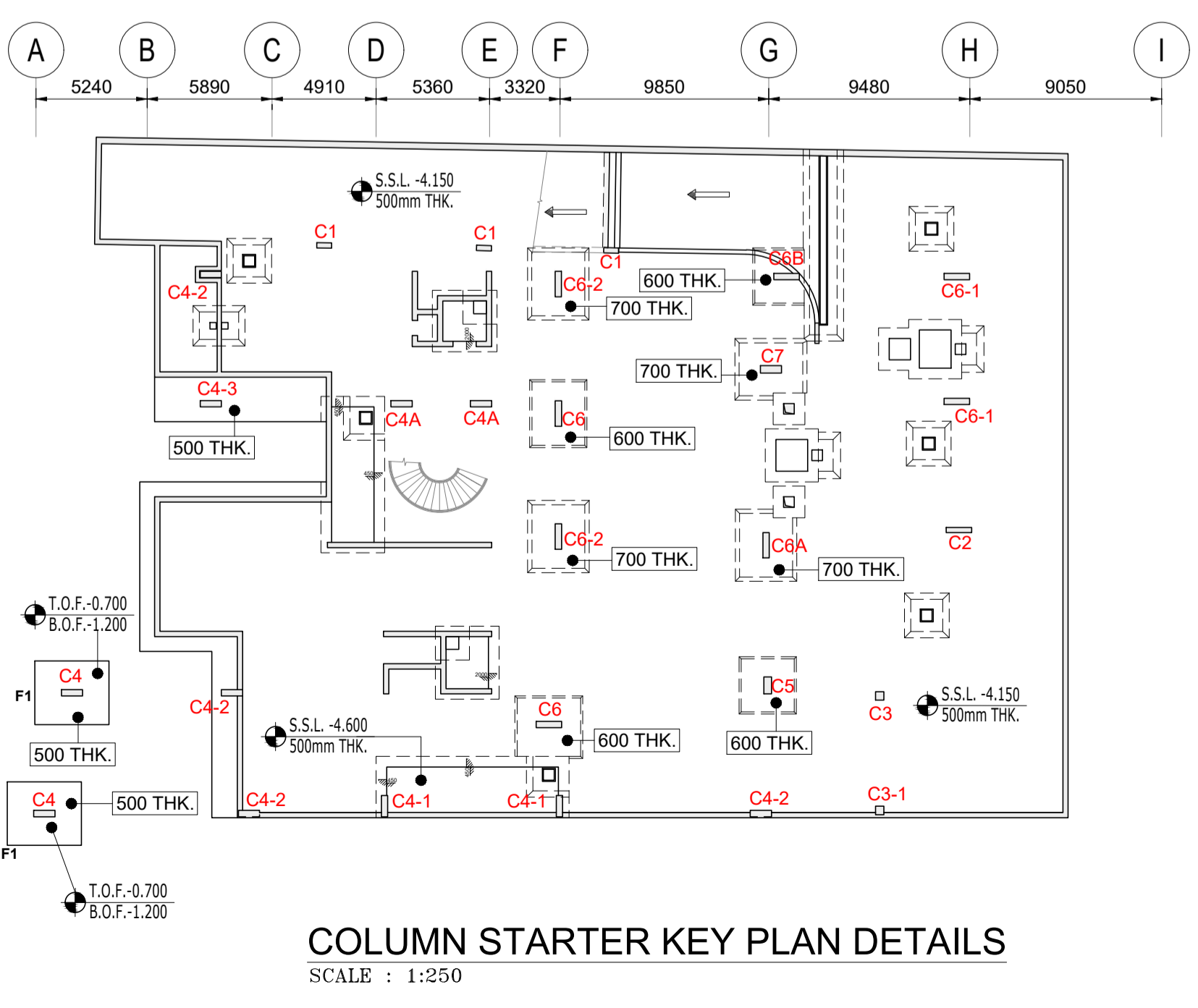

- SHOP DRAWING REFERENCE:**
- SUMP PIT REINFORCEMENT DETAILS : OPI-CSI-A126-SHD-ST-031
  - LIFT PIT & WALL STARTERS REINFORCEMENT DETAILS : OPI-CSI-A126-SHD-ST-032 & 033
  - RAFT SLAB REINFORCEMENT DETAILS : OPI-CSI-A126-SHD-ST-034 & 039
  - RETAINING WALL STARTERS REINFORCEMENT DETAILS : OPI-CSI-A126-SHD-ST-041

Project: Sample project  
Client: FEEL FREE CREATION  
Consultant: FFCM  
Main Contractor: --

Date Prepared: 07-Feb-2025 Date Revised:  
Prepared by: MRR Checked by: FFC

| MEMBER    | BAR MARK | TYPE AND SIZE | NO OF MBRS | NO OF BARS IN EACH | TOTAL NOS. | LENGTH OF EACH BAR | SHAPE CODE | A*  | B*     | C*    | D*    | E/R* | Shape Diagram | Weight in Kg | Rev. |
|-----------|----------|---------------|------------|--------------------|------------|--------------------|------------|-----|--------|-------|-------|------|---------------|--------------|------|
|           |          |               |            |                    |            | mm+                |            | mm  | mm     | mm    | mm    | mm   |               |              |      |
| COLUMN C1 | 101      | T10           | 3          | 4                  | 12         | 1275               | 99165      | 340 | 190    | (130) | (130) |      |               | 9.425        |      |
| COLUMN C1 | 104      | T16           | 3          | 5                  | 15         | 1675               | 11         | 450 | (1250) |       |       |      |               | 39.672       |      |
| COLUMN C1 | 105      | T16           | 3          | 5                  | 15         | 2475               | 11         | 450 | (2050) |       |       |      |               | 58.620       |      |
|           |          |               |            |                    |            |                    |            |     |        |       |       |      |               |              |      |
|           |          |               |            |                    |            |                    |            |     |        |       |       |      |               |              |      |

\* Specified in multiples of 5mm

+ Specified in multiples of 25mm

**Page Total 107.717 (in Kg)**

**Page 1 of 23**

This Schedule complies with the requirements of BS8666-2005

info@dyndigi.com

Project: Sample project  
Client: FEEL FREE CREATION  
Consultant: FFCM  
Main Contractor: --

Date Prepared: 07-Feb-2025 Date Revised:  
Prepared by: MRR Checked by: FFC

| MEMBER    | BAR MARK | TYPE AND SIZE | NO OF MBRS | NO OF BARS IN EACH | TOTAL NOS. | LENGTH OF EACH BAR | SHAPE CODE | A*  | B*     | C*    | D*    | E/R* | Shape Diagram | Weight in Kg | Rev. |
|-----------|----------|---------------|------------|--------------------|------------|--------------------|------------|-----|--------|-------|-------|------|---------------|--------------|------|
|           |          |               |            |                    |            | mm+                |            | mm  | mm     | mm    | mm    | mm   |               |              |      |
| COLUMN C1 | 109      | T12           | 3          | 4                  | 12         | 1925               | 99165      | 190 | 640    | (160) | (160) |      |               | 20.513       |      |
| COLUMN C2 | 104      | T16           | 1          | 8                  | 8          | 1675               | 11         | 450 | (1250) |       |       |      |               | 21.159       |      |
| COLUMN C2 | 105      | T16           | 1          | 8                  | 8          | 2475               | 11         | 450 | (2050) |       |       |      |               | 31.264       |      |
|           |          |               |            |                    |            |                    |            |     |        |       |       |      |               |              |      |
|           |          |               |            |                    |            |                    |            |     |        |       |       |      |               |              |      |

\* Specified in multiples of 5mm

+ Specified in multiples of 25mm

**Page Total 72.936 (in Kg)**

**Page 2 of 23**

This Schedule complies with the requirements of BS8666-2005

info@dyndigi.com

Project: Sample project  
Client: FEEL FREE CREATION  
Consultant: FFCM  
Main Contractor: --

Date Prepared: 07-Feb-2025 Date Revised:  
Prepared by: MRR Checked by: FFC

| MEMBER    | BAR MARK | TYPE AND SIZE | NO OF MBRS | NO OF BARS IN EACH | TOTAL NOS. | LENGTH OF EACH BAR | SHAPE CODE | A*   | B*  | C*    | D*    | E/R* | Shape Diagram                                                                       | Weight in Kg | Rev. |
|-----------|----------|---------------|------------|--------------------|------------|--------------------|------------|------|-----|-------|-------|------|-------------------------------------------------------------------------------------|--------------|------|
|           |          |               |            |                    |            | mm+                |            | mm   | mm  | mm    | mm    | mm   |                                                                                     |              |      |
| COLUMN C2 | 106      | T12           | 1          | 4                  | 4          | 2925               | 99165      | 1140 | 190 | (160) | (160) |      |                                                                                     | 10.390       |      |
| COLUMN C2 | 107      | T10           | 1          | 4                  | 4          | 1400               | 99165      | 405  | 190 | (130) | (130) |      |                                                                                     | 3.450        |      |
| COLUMN C2 | 108      | T10           | 1          | 8                  | 8          | 975                | 99291      | 190  | 260 |       | 250   | 100  |  | 4.805        |      |
|           |          |               |            |                    |            |                    |            |      |     |       |       |      |                                                                                     |              |      |
|           |          |               |            |                    |            |                    |            |      |     |       |       |      |                                                                                     |              |      |

\* Specified in multiples of 5mm

+ Specified in multiples of 25mm

**Page Total 18.645 (in Kg)**

**Page 3 of 23**

This Schedule complies with the requirements of BS8666-2005

info@dyndigi.com

Project: Sample project  
Client: FEEL FREE CREATION  
Consultant: FFCM  
Main Contractor: --

Date Prepared: 07-Feb-2025 Date Revised:  
Prepared by: MRR Checked by: FFC

| MEMBER    | BAR MARK | TYPE AND SIZE | NO OF MBRS | NO OF BARS IN EACH | TOTAL NOS. | LENGTH OF EACH BAR | SHAPE CODE | A*  | B*     | C*    | D*    | E/R* | Shape Diagram | Weight in Kg | Rev. |
|-----------|----------|---------------|------------|--------------------|------------|--------------------|------------|-----|--------|-------|-------|------|---------------|--------------|------|
|           |          |               |            |                    |            | mm+                |            | mm  | mm     | mm    | mm    | mm   |               |              |      |
| COLUMN C3 | 102      | T12           | 1          | 4                  | 4          | 1625               | 99165      | 340 | 340    | (160) | (160) |      |               | 5.772        |      |
| COLUMN C3 | 103      | T10           | 1          | 4                  | 4          | 1200               | 99165      | 250 | 250    | (130) | (130) |      |               | 2.957        |      |
| COLUMN C3 | 104      | T16           | 1          | 4                  | 4          | 1675               | 11         | 450 | (1250) |       |       |      |               | 10.579       |      |
|           |          |               |            |                    |            |                    |            |     |        |       |       |      |               |              |      |
|           |          |               |            |                    |            |                    |            |     |        |       |       |      |               |              |      |

\* Specified in multiples of 5mm

+ Specified in multiples of 25mm

**Page Total 19.308 (in Kg)**

**Page 4 of 23**

This Schedule complies with the requirements of BS8666-2005

info@dyndigi.com

Project: Sample project  
Client: FEEL FREE CREATION  
Consultant: FFCM  
Main Contractor: --

Date Prepared: 07-Feb-2025 Date Revised:  
Prepared by: MRR Checked by: FFC

| MEMBER      | BAR MARK | TYPE AND SIZE | NO OF MBRS | NO OF BARS IN EACH | TOTAL NOS. | LENGTH OF EACH BAR | SHAPE CODE | A*  | B*     | C*    | D*    | E/R* | Shape Diagram | Weight in Kg | Rev. |
|-------------|----------|---------------|------------|--------------------|------------|--------------------|------------|-----|--------|-------|-------|------|---------------|--------------|------|
|             |          |               |            |                    |            | mm+                |            | mm  | mm     | mm    | mm    | mm   |               |              |      |
| COLUMN C3   | 105      | T16           | 1          | 4                  | 4          | 2475               | 11         | 450 | (2050) |       |       |      |               | 15.632       |      |
| COLUMN C3-1 | 102      | T12           | 1          | 4                  | 4          | 1625               | 99165      | 340 | 340    | (160) | (160) |      |               | 5.772        |      |
| COLUMN C3-1 | 103      | T10           | 1          | 4                  | 4          | 1200               | 99165      | 250 | 250    | (130) | (130) |      |               | 2.957        |      |
|             |          |               |            |                    |            |                    |            |     |        |       |       |      |               |              |      |
|             |          |               |            |                    |            |                    |            |     |        |       |       |      |               |              |      |

\* Specified in multiples of 5mm

+ Specified in multiples of 25mm

**Page Total 24.361 (in Kg)**  
**Page 5 of 23**

This Schedule complies with the requirements of BS8666-2005

info@dyndigi.com

Project: Sample project  
Client: FEEL FREE CREATION  
Consultant: FFCM  
Main Contractor: --

Date Prepared: 07-Feb-2025 Date Revised:  
Prepared by: MRR Checked by: FFC

| MEMBER      | BAR MARK | TYPE AND SIZE | NO OF MBRS | NO OF BARS IN EACH | TOTAL NOS. | LENGTH OF EACH BAR | SHAPE CODE | A*  | B*     | C* | D*  | E/R* | Shape Diagram                                                                       | Weight in Kg | Rev. |
|-------------|----------|---------------|------------|--------------------|------------|--------------------|------------|-----|--------|----|-----|------|-------------------------------------------------------------------------------------|--------------|------|
|             |          |               |            |                    |            | mm+                |            | mm  | mm     | mm | mm  | mm   |                                                                                     |              |      |
| COLUMN C3-1 | 125      | T16           | 1          | 4                  | 4          | 2625               | 11         | 450 | (2200) |    |     |      |                                                                                     | 16.580       |      |
| COLUMN C3-1 | 126      | T16           | 1          | 4                  | 4          | 1825               | 11         | 450 | (1400) |    |     |      |                                                                                     | 11.527       |      |
| COLUMN C4   | 110      | T10           | 2          | 20                 | 40         | 950                | 99291      | 240 | 225    |    | 200 | 100  |  | 23.408       |      |
|             |          |               |            |                    |            |                    |            |     |        |    |     |      |                                                                                     |              |      |
|             |          |               |            |                    |            |                    |            |     |        |    |     |      |                                                                                     |              |      |

\* Specified in multiples of 5mm

+ Specified in multiples of 25mm

Page Total 51.515 (in Kg)

Page 6 of 23

This Schedule complies with the requirements of BS8666-2005

Project: Sample project  
Client: FEEL FREE CREATION  
Consultant: FFCM  
Main Contractor: --

Date Prepared: 07-Feb-2025

Date Revised:

Prepared by: MRR

Checked by: FFC

| MEMBER    | BAR MARK | TYPE AND SIZE | NO OF MBRS | NO OF BARS IN EACH | TOTAL NOS. | LENGTH OF EACH BAR | SHAPE CODE | A*  | B*     | C*    | D*    | E/R* | Shape Diagram | Weight in Kg | Rev. |
|-----------|----------|---------------|------------|--------------------|------------|--------------------|------------|-----|--------|-------|-------|------|---------------|--------------|------|
|           |          |               |            |                    |            | mm+                |            | mm  | mm     | mm    | mm    | mm   |               |              |      |
| COLUMN C4 | 111      | T10           | 2          | 10                 | 20         | 1375               | 99165      | 340 | 240    | (130) | (130) |      |               | 16.940       |      |
| COLUMN C4 | 112      | T12           | 2          | 10                 | 20         | 2625               | 99165      | 940 | 240    | (160) | (160) |      |               | 46.620       |      |
| COLUMN C4 | 132      | T16           | 2          | 8                  | 16         | 2700               | 11         | 450 | (2275) |       |       |      |               | 68.213       |      |
|           |          |               |            |                    |            |                    |            |     |        |       |       |      |               |              |      |
|           |          |               |            |                    |            |                    |            |     |        |       |       |      |               |              |      |

\* Specified in multiples of 5mm

+ Specified in multiples of 25mm

**Page Total 131.773 (in Kg)**

**Page 7 of 23**

This Schedule complies with the requirements of BS8666-2005



Project: Sample project  
Client: FEEL FREE CREATION  
Consultant: FFCM  
Main Contractor: --

Date Prepared: 07-Feb-2025 Date Revised:  
Prepared by: MRR Checked by: FFC

| MEMBER      | BAR MARK | TYPE AND SIZE | NO OF MBRS | NO OF BARS IN EACH | TOTAL NOS. | LENGTH OF EACH BAR | SHAPE CODE | A*  | B*     | C*    | D*    | E/R* | Shape Diagram                                                                       | Weight in Kg | Rev. |
|-------------|----------|---------------|------------|--------------------|------------|--------------------|------------|-----|--------|-------|-------|------|-------------------------------------------------------------------------------------|--------------|------|
|             |          |               |            |                    |            | mm+                |            | mm  | mm     | mm    | mm    | mm   |                                                                                     |              |      |
| COLUMN C4   | 133      | T16           | 2          | 8                  | 16         | 3500               | 11         | 450 | (3075) |       |       |      |                                                                                     | 88.424       |      |
| COLUMN C4-1 | 110      | T10           | 2          | 8                  | 16         | 950                | 99291      | 240 | 225    |       | 200   | 30   |  | 9.363        |      |
| COLUMN C4-1 | 111      | T10           | 2          | 4                  | 8          | 1375               | 99165      | 340 | 240    | (130) | (130) |      |                                                                                     | 6.776        |      |
|             |          |               |            |                    |            |                    |            |     |        |       |       |      |                                                                                     |              |      |
|             |          |               |            |                    |            |                    |            |     |        |       |       |      |                                                                                     |              |      |

\* Specified in multiples of 5mm

+ Specified in multiples of 25mm

**Page Total 104.563 (in Kg)**

**Page 8 of 23**

This Schedule complies with the requirements of BS8666-2005

info@dyndigi.com

Project: Sample project  
Client: FEEL FREE CREATION  
Consultant: FFCM  
Main Contractor: --

Date Prepared: 07-Feb-2025 Date Revised:  
Prepared by: MRR Checked by: FFC

| MEMBER      | BAR MARK | TYPE AND SIZE | NO OF MBRS | NO OF BARS IN EACH | TOTAL NOS. | LENGTH OF EACH BAR | SHAPE CODE | A*  | B*     | C*    | D*    | E/R* | Shape Diagram | Weight in Kg | Rev. |
|-------------|----------|---------------|------------|--------------------|------------|--------------------|------------|-----|--------|-------|-------|------|---------------|--------------|------|
|             |          |               |            |                    |            | mm+                |            | mm  | mm     | mm    | mm    | mm   |               |              |      |
| COLUMN C4-1 | 112      | T12           | 2          | 4                  | 8          | 2625               | 99165      | 940 | 240    | (160) | (160) |      |               | 18.648       |      |
| COLUMN C4-1 | 130      | T16           | 2          | 8                  | 16         | 3075               | 11         | 450 | (2650) |       |       |      |               | 77.687       |      |
| COLUMN C4-1 | 131      | T16           | 2          | 8                  | 16         | 2275               | 11         | 450 | (1850) |       |       |      |               | 57.476       |      |
|             |          |               |            |                    |            |                    |            |     |        |       |       |      |               |              |      |
|             |          |               |            |                    |            |                    |            |     |        |       |       |      |               |              |      |

\* Specified in multiples of 5mm

+ Specified in multiples of 25mm

**Page Total 153.811 (in Kg)**

**Page 9 of 23**

This Schedule complies with the requirements of BS8666-2005

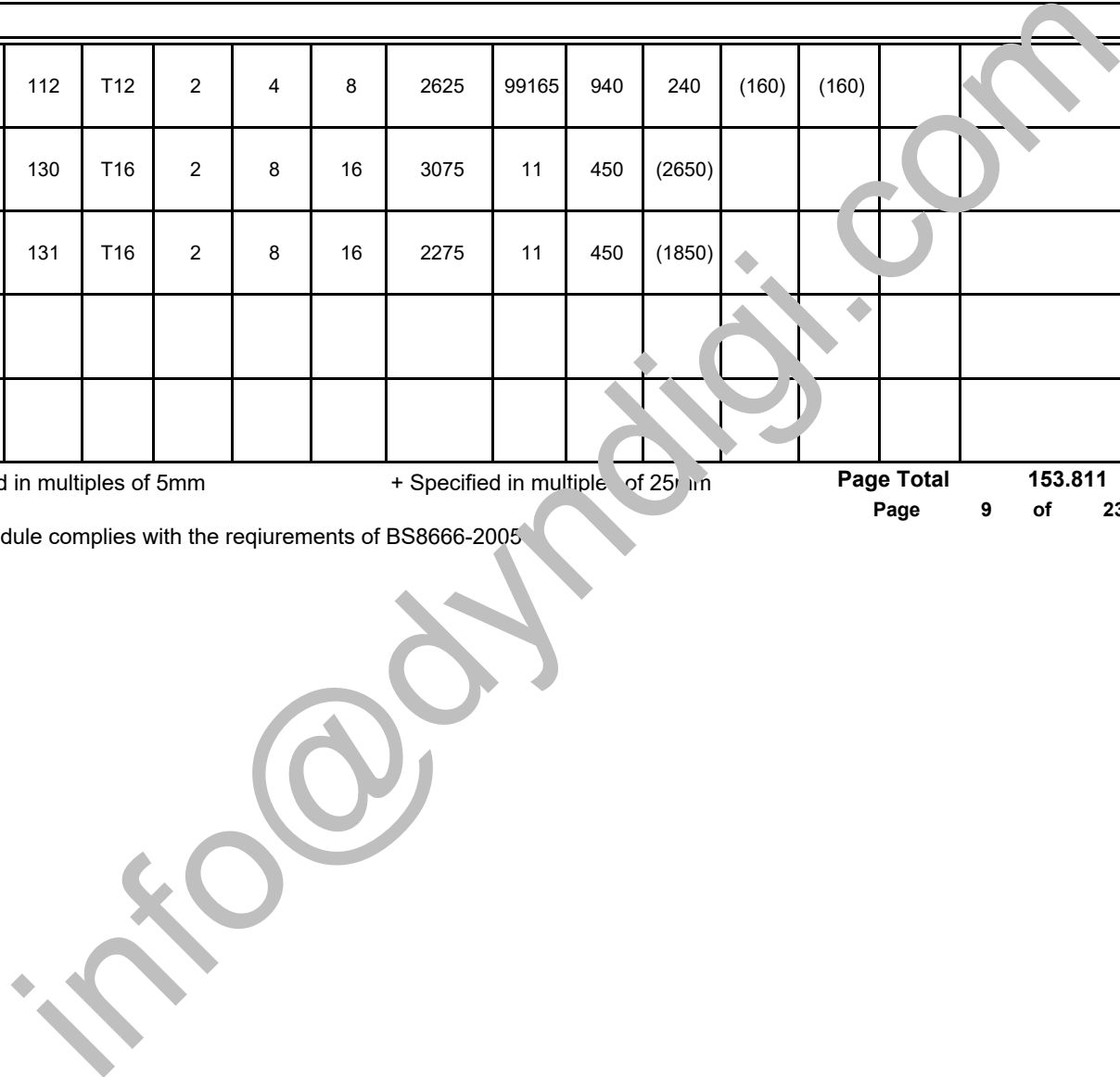

Project: Sample project  
Client: FEEL FREE CREATION  
Consultant: FFCM  
Main Contractor: --

Date Prepared: 07-Feb-2025 Date Revised:  
Prepared by: MRR Checked by: FFC

| MEMBER      | BAR MARK | TYPE AND SIZE | NO OF MBRS | NO OF BARS IN EACH | TOTAL NOS. | LENGTH OF EACH BAR | SHAPE CODE | A*  | B*  | C*    | D*    | E/R* | Shape Diagram                                                                       | Weight in Kg | Rev. |
|-------------|----------|---------------|------------|--------------------|------------|--------------------|------------|-----|-----|-------|-------|------|-------------------------------------------------------------------------------------|--------------|------|
|             |          |               |            |                    |            | mm+                |            | mm  | mm  | mm    | mm    | mm   |                                                                                     |              |      |
| COLUMN C4-2 | 110      | T10           | 4          | 8                  | 32         | 950                | 99291      | 240 | 225 |       | 200   | 130  |  | 18.726       |      |
| COLUMN C4-2 | 111      | T10           | 4          | 4                  | 16         | 1375               | 99165      | 340 | 240 | (130) | (130) |      |                                                                                     | 13.552       |      |
| COLUMN C4-2 | 112      | T12           | 4          | 4                  | 16         | 2625               | 99165      | 940 | 240 | (160) | (160) |      |                                                                                     | 37.296       |      |
|             |          |               |            |                    |            |                    |            |     |     |       |       |      |                                                                                     |              |      |
|             |          |               |            |                    |            |                    |            |     |     |       |       |      |                                                                                     |              |      |

\* Specified in multiples of 5mm

+ Specified in multiples of 25mm

Page Total 69.574 (in Kg)

Page 10 of 23

This Schedule complies with the requirements of BS8666-2005

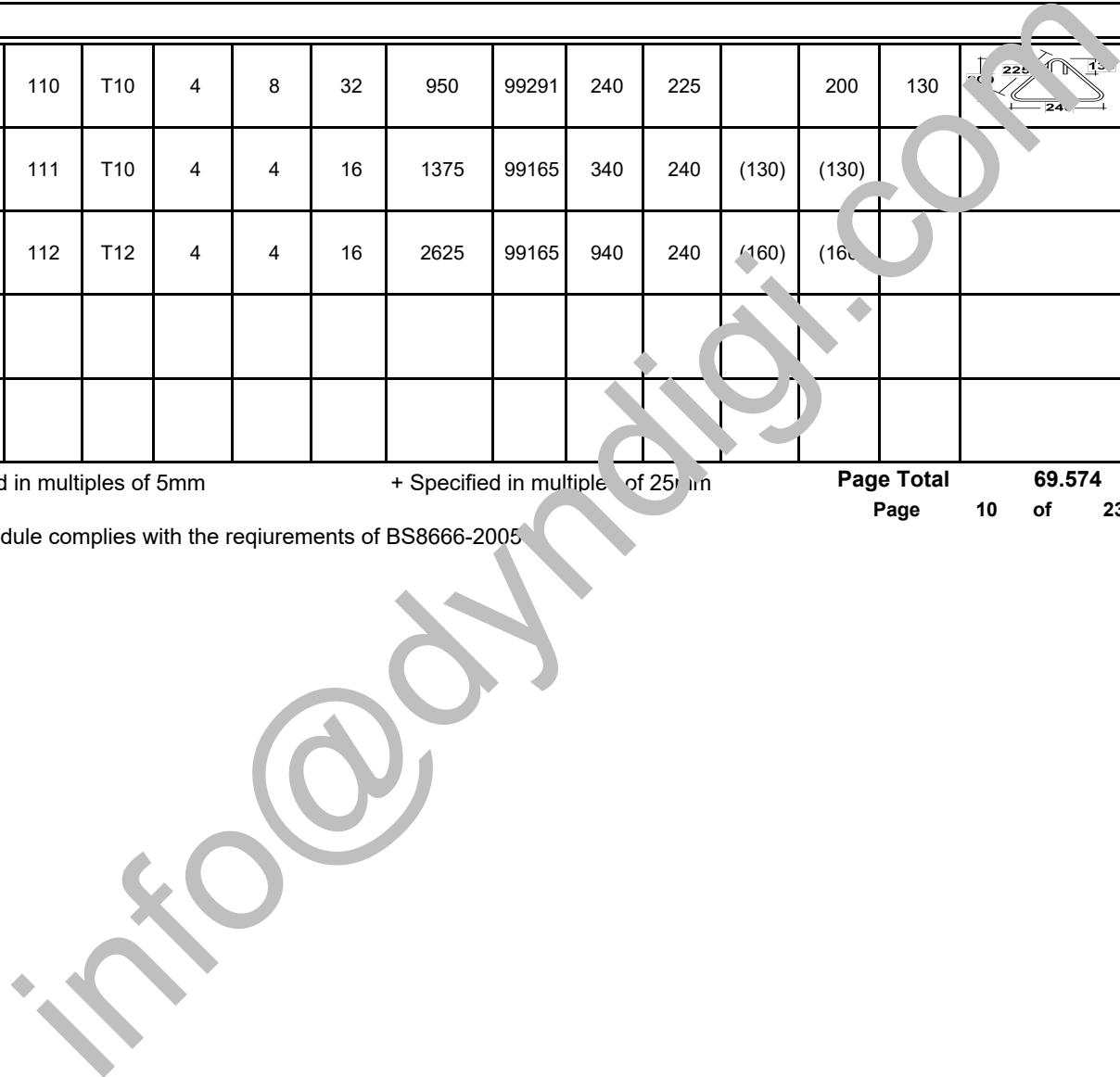

Project: Sample project  
Client: FEEL FREE CREATION  
Consultant: FFCM  
Main Contractor: --

Date Prepared: 07-Feb-2025 Date Revised:  
Prepared by: MRR Checked by: FFC

| MEMBER          | BAR MARK | TYPE AND SIZE | NO OF MBRS | NO OF BARS IN EACH | TOTAL NOS. | LENGTH OF EACH BAR | SHAPE CODE | A*  | B*     | C* | D* | E/R* | Shape Diagram | Weight in Kg | Rev. |
|-----------------|----------|---------------|------------|--------------------|------------|--------------------|------------|-----|--------|----|----|------|---------------|--------------|------|
|                 |          |               |            |                    |            | mm+                |            | mm  | mm     | mm | mm | mm   |               |              |      |
| COLUMN C4-2     | 125      | T16           | 4          | 8                  | 32         | 2625               | 11         | 450 | (2200) |    |    |      |               | 132.636      |      |
| COLUMN C4-2     | 126      | T16           | 4          | 8                  | 32         | 1825               | 11         | 450 | (1400) |    |    |      |               | 92.214       |      |
| COLUMN C4-3&C4A | 104      | T16           | 3          | 8                  | 24         | 1675               | 11         | 450 | (1250) |    |    |      |               | 63.476       |      |
|                 |          |               |            |                    |            |                    |            |     |        |    |    |      |               |              |      |
|                 |          |               |            |                    |            |                    |            |     |        |    |    |      |               |              |      |

\* Specified in multiples of 5mm

+ Specified in multiples of 25mm

**Page Total 288.326 (in Kg)**

**Page 11 of 23**

This Schedule complies with the requirements of BS8666-2005

info@dyndigi.com

Project: Sample project  
Client: FEEL FREE CREATION  
Consultant: FFCM  
Main Contractor: --

Date Prepared: 07-Feb-2025 Date Revised:  
Prepared by: MRR Checked by: FFC

| MEMBER          | BAR MARK | TYPE AND SIZE | NO OF MBRS | NO OF BARS IN EACH | TOTAL NOS. | LENGTH OF EACH BAR | SHAPE CODE | A*  | B*     | C*    | D*    | E/R* | Shape Diagram                                                                       | Weight in Kg | Rev. |
|-----------------|----------|---------------|------------|--------------------|------------|--------------------|------------|-----|--------|-------|-------|------|-------------------------------------------------------------------------------------|--------------|------|
|                 |          |               |            |                    |            | mm+                |            | mm  | mm     | mm    | mm    | mm   |                                                                                     |              |      |
| COLUMN C4-3&C4A | 105      | T16           | 3          | 8                  | 24         | 2475               | 11         | 450 | (2050) |       |       |      |                                                                                     | 93.793       |      |
| COLUMN C4-3&C4A | 110      | T10           | 3          | 8                  | 24         | 950                | 99291      | 240 | 225    |       | 200   | 30   |  | 14.045       |      |
| COLUMN C4-3&C4A | 111      | T10           | 3          | 4                  | 12         | 1375               | 99165      | 340 | 240    | (130) | (130) |      |                                                                                     | 10.164       |      |
|                 |          |               |            |                    |            |                    |            |     |        |       |       |      |                                                                                     |              |      |
|                 |          |               |            |                    |            |                    |            |     |        |       |       |      |                                                                                     |              |      |

\* Specified in multiples of 5mm

+ Specified in multiples of 25mm

Page Total 118.002 (in Kg)

Page 12 of 23

This Schedule complies with the requirements of BS8666-2005

info@dyndigi.com

Project: Sample project  
Client: FEEL FREE CREATION  
Consultant: FFCM  
Main Contractor: --

Date Prepared: 07-Feb-2025 Date Revised:  
Prepared by: MRR Checked by: FFC

| MEMBER          | BAR MARK | TYPE AND SIZE | NO OF MBRS | NO OF BARS IN EACH | TOTAL NOS. | LENGTH OF EACH BAR | SHAPE CODE | A*  | B*  | C*    | D*    | E/R* | Shape Diagram | Weight in Kg | Rev. |
|-----------------|----------|---------------|------------|--------------------|------------|--------------------|------------|-----|-----|-------|-------|------|---------------|--------------|------|
|                 |          |               |            |                    |            | mm+                |            | mm  | mm  | mm    | mm    | mm   |               |              |      |
| COLUMN C4-3&C4A | 112      | T12           | 3          | 4                  | 12         | 2625               | 99165      | 940 | 240 | (160) | (160) |      |               | 27.972       |      |
| COLUMN C5       | 113      | T10           | 1          | 4                  | 4          | 1150               | 99165      | 175 | 290 | (130) | (130) |      |               | 2.834        |      |
| COLUMN C5       | 114      | T12           | 1          | 4                  | 4          | 2325               | 99165      | 290 | 740 | (160) | (160) |      |               | 8.258        |      |
|                 |          |               |            |                    |            |                    |            |     |     |       |       |      |               |              |      |
|                 |          |               |            |                    |            |                    |            |     |     |       |       |      |               |              |      |

\* Specified in multiples of 5mm

+ Specified in multiples of 25mm

**Page Total 39.064 (in Kg)**

**Page 13 of 23**

This Schedule complies with the requirements of BS8666-2005

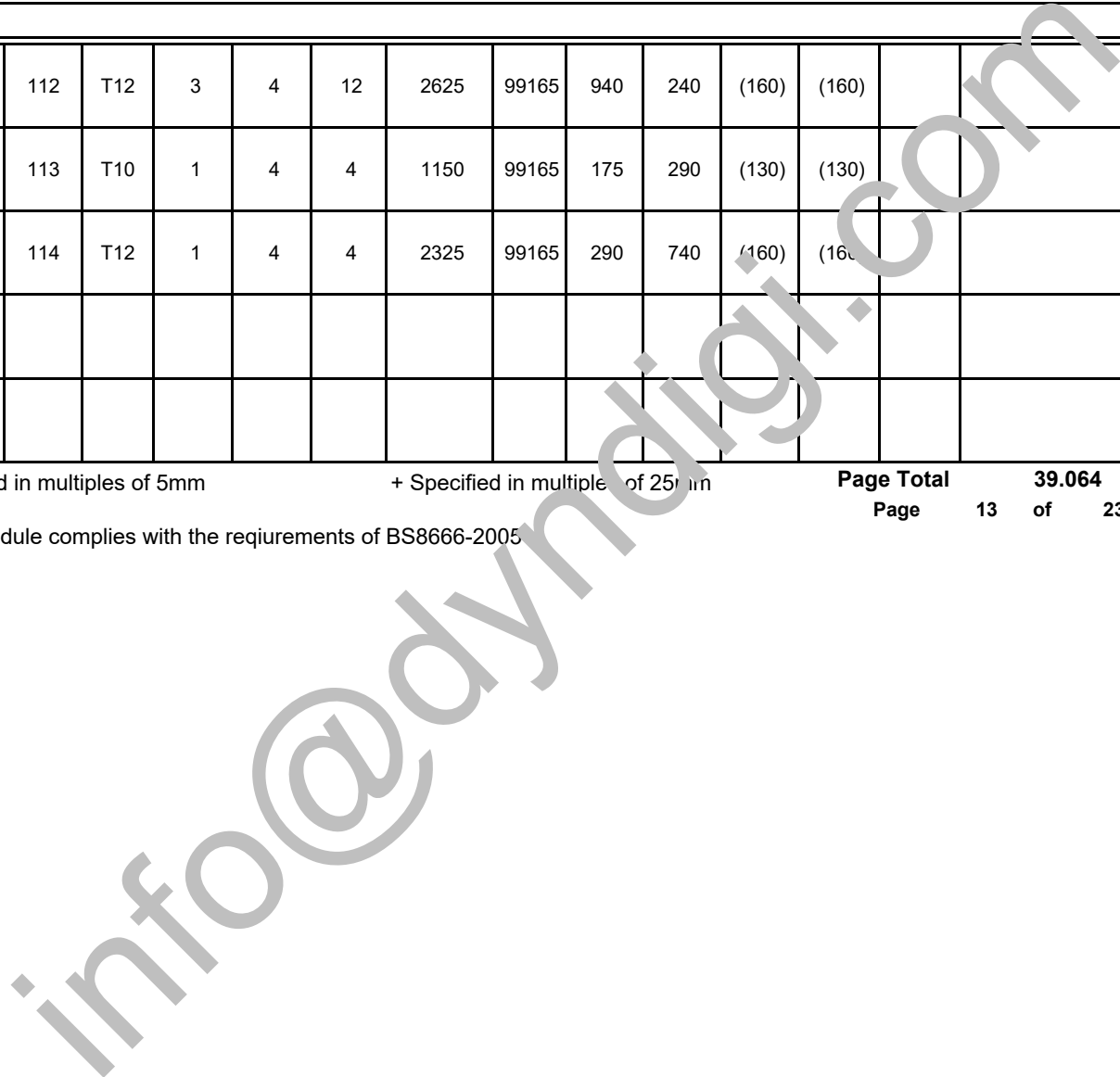

Project: Sample project  
Client: FEEL FREE CREATION  
Consultant: FFCM  
Main Contractor: --

Date Prepared: 07-Feb-2025 Date Revised:  
Prepared by: MRR Checked by: FFC

| MEMBER    | BAR MARK | TYPE AND SIZE | NO OF MBRS | NO OF BARS IN EACH | TOTAL NOS. | LENGTH OF EACH BAR | SHAPE CODE | A*  | B*     | C* | D*  | E/R* | Shape Diagram                                                                       | Weight in Kg | Rev. |
|-----------|----------|---------------|------------|--------------------|------------|--------------------|------------|-----|--------|----|-----|------|-------------------------------------------------------------------------------------|--------------|------|
|           |          |               |            |                    |            | mm+                |            | mm  | mm     | mm | mm  | mm   |                                                                                     |              |      |
| COLUMN C5 | 115      | T10           | 1          | 8                  | 8          | 1025               | 99291      | 290 | 230    |    | 185 | 130  |  | 5.051        |      |
| COLUMN C5 | 116      | T16           | 1          | 7                  | 7          | 2575               | 11         | 450 | (2150) |    |     |      |                                                                                     | 28.461       |      |
| COLUMN C5 | 127      | T16           | 1          | 7                  | 7          | 1775               | 11         | 450 | (1350) |    |     |      |                                                                                     | 19.619       |      |
|           |          |               |            |                    |            |                    |            |     |        |    |     |      |                                                                                     |              |      |
|           |          |               |            |                    |            |                    |            |     |        |    |     |      |                                                                                     |              |      |

\* Specified in multiples of 5mm

+ Specified in multiples of 25mm

**Page Total 53.131 (in Kg)**

**Page 14 of 23**

This Schedule complies with the requirements of BS8666-2005

info@dyndigi.com

Project: Sample project  
Client: FEEL FREE CREATION  
Consultant: FFCM  
Main Contractor: --

Date Prepared: 07-Feb-2025 Date Revised:  
Prepared by: MRR Checked by: FFC

| MEMBER        | BAR MARK | TYPE AND SIZE | NO OF MBRS | NO OF BARS IN EACH | TOTAL NOS. | LENGTH OF EACH BAR | SHAPE CODE | A*  | B*     | C*    | D*    | E/R* | Shape Diagram                                                                       | Weight in Kg | Rev. |
|---------------|----------|---------------|------------|--------------------|------------|--------------------|------------|-----|--------|-------|-------|------|-------------------------------------------------------------------------------------|--------------|------|
|               |          |               |            |                    |            | mm+                |            | mm  | mm     | mm    | mm    | mm   |                                                                                     |              |      |
| COLUMN C6&C6B | 116      | T16           | 3          | 9                  | 27         | 2575               | 11         | 450 | (2150) |       |       |      |                                                                                     | 109.780      |      |
| COLUMN C6&C6B | 117      | T10           | 3          | 8                  | 24         | 1075               | 99165      | 195 | 240    | (130) | (130) |      |                                                                                     | 15.893       |      |
| COLUMN C6&C6B | 118      | T10           | 3          | 8                  | 24         | 975                | 99291      | 240 | 235    |       | 210   | 100  |  | 14.414       |      |
|               |          |               |            |                    |            |                    |            |     |        |       |       |      |                                                                                     |              |      |
|               |          |               |            |                    |            |                    |            |     |        |       |       |      |                                                                                     |              |      |

\* Specified in multiples of 5mm

+ Specified in multiples of 25mm

Page Total 140.087 (in Kg)

Page 15 of 23

This Schedule complies with the requirements of BS8666-2005

info@dyndigi.com



Project: Sample project  
Client: FEEL FREE CREATION  
Consultant: FFCM  
Main Contractor: --

Date Prepared: 07-Feb-2025 Date Revised:  
Prepared by: MRR Checked by: FFC

| MEMBER        | BAR MARK | TYPE AND SIZE | NO OF MBRS | NO OF BARS IN EACH | TOTAL NOS. | LENGTH OF EACH BAR | SHAPE CODE | A*   | B*     | C*    | D*    | E/R* | Shape Diagram | Weight in Kg | Rev. |
|---------------|----------|---------------|------------|--------------------|------------|--------------------|------------|------|--------|-------|-------|------|---------------|--------------|------|
|               |          |               |            |                    |            | mm+                |            | mm   | mm     | mm    | mm    | mm   |               |              |      |
| COLUMN C6&C6B | 119      | T12           | 3          | 4                  | 12         | 3025               | 99165      | 1140 | 240    | (160) | (160) |      |               | 32.234       |      |
| COLUMN C6&C6B | 127      | T16           | 3          | 9                  | 27         | 1775               | 11         | 450  | (1350) |       |       |      |               | 75.674       |      |
| COLUMN C6-1   | 104      | T16           | 2          | 9                  | 18         | 1675               | 11         | 450  | (1250) |       |       |      |               | 47.607       |      |
|               |          |               |            |                    |            |                    |            |      |        |       |       |      |               |              |      |
|               |          |               |            |                    |            |                    |            |      |        |       |       |      |               |              |      |

\* Specified in multiples of 5mm

+ Specified in multiples of 25mm

**Page Total 155.515 (in Kg)**

**Page 16 of 23**

This Schedule complies with the requirements of BS8666-2005

info@dyndigi.com

Project: Sample project  
Client: FEEL FREE CREATION  
Consultant: FFCM  
Main Contractor: --

Date Prepared: 07-Feb-2025 Date Revised:  
Prepared by: MRR Checked by: FFC

| MEMBER      | BAR MARK | TYPE AND SIZE | NO OF MBRS | NO OF BARS IN EACH | TOTAL NOS. | LENGTH OF EACH BAR | SHAPE CODE | A*  | B*     | C*    | D*    | E/R* | Shape Diagram                                                                       | Weight in Kg | Rev. |
|-------------|----------|---------------|------------|--------------------|------------|--------------------|------------|-----|--------|-------|-------|------|-------------------------------------------------------------------------------------|--------------|------|
|             |          |               |            |                    |            | mm+                |            | mm  | mm     | mm    | mm    | mm   |                                                                                     |              |      |
| COLUMN C6-1 | 105      | T16           | 2          | 9                  | 18         | 2475               | 11         | 450 | (2050) |       |       |      |                                                                                     | 70.344       |      |
| COLUMN C6-1 | 117      | T10           | 2          | 8                  | 16         | 1075               | 99165      | 195 | 240    | (130) | (130) |      |                                                                                     | 10.595       |      |
| COLUMN C6-1 | 118      | T10           | 2          | 8                  | 16         | 975                | 99291      | 240 | 235    |       | 210   | 100  |  | 9.610        |      |
|             |          |               |            |                    |            |                    |            |     |        |       |       |      |                                                                                     |              |      |
|             |          |               |            |                    |            |                    |            |     |        |       |       |      |                                                                                     |              |      |

\* Specified in multiples of 5mm

+ Specified in multiples of 25mm

**Page Total 90.549 (in Kg)**

**Page 17 of 23**

This Schedule complies with the requirements of BS8666-2005

info@dyndigi.com

Project: Sample project  
Client: FEEL FREE CREATION  
Consultant: FFCM  
Main Contractor: --

Date Prepared: 07-Feb-2025 Date Revised:  
Prepared by: MRR Checked by: FFC

| MEMBER      | BAR MARK | TYPE AND SIZE | NO OF MBRS | NO OF BARS IN EACH | TOTAL NOS. | LENGTH OF EACH BAR | SHAPE CODE | A*   | B*  | C*    | D*    | E/R* | Shape Diagram                                                                       | Weight in Kg | Rev. |
|-------------|----------|---------------|------------|--------------------|------------|--------------------|------------|------|-----|-------|-------|------|-------------------------------------------------------------------------------------|--------------|------|
|             |          |               |            |                    |            | mm+                |            | mm   | mm  | mm    | mm    | mm   |                                                                                     |              |      |
| COLUMN C6-1 | 119      | T12           | 2          | 4                  | 8          | 3025               | 99165      | 1140 | 240 | (160) | (160) |      |                                                                                     | 21.490       |      |
| COLUMN C6-2 | 117      | T10           | 2          | 8                  | 16         | 1075               | 99165      | 195  | 240 | (130) | (130) |      |                                                                                     | 10.595       |      |
| COLUMN C6-2 | 118      | T10           | 2          | 8                  | 16         | 975                | 99291      | 240  | 235 |       | 210   | 100  |  | 9.610        |      |
|             |          |               |            |                    |            |                    |            |      |     |       |       |      |                                                                                     |              |      |
|             |          |               |            |                    |            |                    |            |      |     |       |       |      |                                                                                     |              |      |

\* Specified in multiples of 5mm

+ Specified in multiples of 25mm

**Page Total 41.695 (in Kg)**

**Page 18 of 23**

This Schedule complies with the requirements of BS8666-2005

info@dyndigi.com

Project: Sample project  
Client: FEEL FREE CREATION  
Consultant: FFCM  
Main Contractor: --

Date Prepared: 07-Feb-2025 Date Revised:  
Prepared by: MRR Checked by: FFC

| MEMBER      | BAR MARK | TYPE AND SIZE | NO OF MBRS | NO OF BARS IN EACH | TOTAL NOS. | LENGTH OF EACH BAR | SHAPE CODE | A*   | B*     | C*    | D*    | E/R* | Shape Diagram | Weight in Kg | Rev. |
|-------------|----------|---------------|------------|--------------------|------------|--------------------|------------|------|--------|-------|-------|------|---------------|--------------|------|
|             |          |               |            |                    |            | mm+                |            | mm   | mm     | mm    | mm    | mm   |               |              |      |
| COLUMN C6-2 | 119      | T12           | 2          | 4                  | 8          | 3025               | 99165      | 1140 | 240    | (160) | (160) |      |               | 21.490       |      |
| COLUMN C6-2 | 120      | T16           | 2          | 9                  | 18         | 2675               | 11         | 450  | (2250) |       |       |      |               | 76.029       |      |
| COLUMN C6-2 | 129      | T16           | 2          | 9                  | 18         | 1875               | 11         | 450  | (1450) |       |       |      |               | 53.291       |      |
|             |          |               |            |                    |            |                    |            |      |        |       |       |      |               |              |      |
|             |          |               |            |                    |            |                    |            |      |        |       |       |      |               |              |      |

\* Specified in multiples of 5mm

+ Specified in multiples of 25mm

**Page Total 150.810 (in Kg)**

**Page 19 of 23**

This Schedule complies with the requirements of BS8666-2005

info@dyndigi.com

Project: Sample project  
Client: FEEL FREE CREATION  
Consultant: FFCM  
Main Contractor: --

Date Prepared: 07-Feb-2025 Date Revised:  
Prepared by: MRR Checked by: FFC

| MEMBER     | BAR MARK | TYPE AND SIZE | NO OF MBRS | NO OF BARS IN EACH | TOTAL NOS. | LENGTH OF EACH BAR | SHAPE CODE | A*   | B*  | C*    | D*    | E/R* | Shape Diagram                                                                       | Weight in Kg | Rev. |
|------------|----------|---------------|------------|--------------------|------------|--------------------|------------|------|-----|-------|-------|------|-------------------------------------------------------------------------------------|--------------|------|
|            |          |               |            |                    |            | mm+                |            | mm   | mm  | mm    | mm    | mm   |                                                                                     |              |      |
| COLUMN C6A | 117      | T10           | 1          | 8                  | 8          | 1075               | 99165      | 195  | 240 | (130) | (130) |      |                                                                                     | 5.298        |      |
| COLUMN C6A | 118      | T10           | 1          | 8                  | 8          | 975                | 99291      | 240  | 235 |       | 210   | 30   |  | 4.805        |      |
| COLUMN C6A | 119      | T12           | 1          | 4                  | 4          | 3025               | 99165      | 1140 | 240 | (160) | (160) |      |                                                                                     | 10.745       |      |
|            |          |               |            |                    |            |                    |            |      |     |       |       |      |                                                                                     |              |      |
|            |          |               |            |                    |            |                    |            |      |     |       |       |      |                                                                                     |              |      |

\* Specified in multiples of 5mm

+ Specified in multiples of 25mm

Page Total 20.848 (in Kg)

Page 20 of 23

This Schedule complies with the requirements of BS8666-2005

info@dyndigi.com

Project: Sample project  
Client: FEEL FREE CREATION  
Consultant: FFCM  
Main Contractor: --

Date Prepared: 07-Feb-2025 Date Revised:  
Prepared by: MRR Checked by: FFC

| MEMBER     | BAR MARK | TYPE AND SIZE | NO OF MBRS | NO OF BARS IN EACH | TOTAL NOS. | LENGTH OF EACH BAR | SHAPE CODE | A*  | B*     | C* | D* | E/R* | Shape Diagram | Weight in Kg | Rev. |
|------------|----------|---------------|------------|--------------------|------------|--------------------|------------|-----|--------|----|----|------|---------------|--------------|------|
|            |          |               |            |                    |            | mm+                |            | mm  | mm     | mm | mm | mm   |               |              |      |
| COLUMN C6A | 121      | T20           | 1          | 9                  | 9          | 3050               | 11         | 450 | (2650) |    |    |      |               | 67.692       |      |
| COLUMN C6A | 128      | T20           | 1          | 9                  | 9          | 2050               | 11         | 450 | (1650) |    |    |      |               | 45.498       |      |
| COLUMN C7  | 120      | T16           | 1          | 9                  | 9          | 2675               | 11         | 450 | (2250) |    |    |      |               | 38.014       |      |
|            |          |               |            |                    |            |                    |            |     |        |    |    |      |               |              |      |
|            |          |               |            |                    |            |                    |            |     |        |    |    |      |               |              |      |

\* Specified in multiples of 5mm

+ Specified in multiples of 25mm

**Page Total 151.204 (in Kg)**

**Page 21 of 23**

This Schedule complies with the requirements of BS8666-2005

info@dyndigi.com

Project: Sample project  
Client: FEEL FREE CREATION  
Consultant: FFCM  
Main Contractor: --

Date Prepared: 07-Feb-2025 Date Revised:  
Prepared by: MRR Checked by: FFC

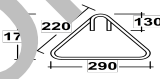
| MEMBER    | BAR MARK | TYPE AND SIZE | NO OF MBRS | NO OF BARS IN EACH | TOTAL NOS. | LENGTH OF EACH BAR | SHAPE CODE | A*  | B*  | C*    | D*    | E/R* | Shape Diagram                                                                       | Weight in Kg | Rev. |
|-----------|----------|---------------|------------|--------------------|------------|--------------------|------------|-----|-----|-------|-------|------|-------------------------------------------------------------------------------------|--------------|------|
|           |          |               |            |                    |            | mm+                |            | mm  | mm  | mm    | mm    | mm   |                                                                                     |              |      |
| COLUMN C7 | 122      | T12           | 1          | 4                  | 4          | 2725               | 99165      | 290 | 940 | (160) | (160) |      |                                                                                     | 9.679        |      |
| COLUMN C7 | 123      | T10           | 1          | 8                  | 8          | 1000               | 99291      | 290 | 220 |       | 170   | 30   |  | 4.928        |      |
| COLUMN C7 | 124      | T10           | 1          | 4                  | 4          | 1125               | 99165      | 165 | 290 | (130) | (130) |      |                                                                                     | 2.772        |      |
|           |          |               |            |                    |            |                    |            |     |     |       |       |      |                                                                                     |              |      |
|           |          |               |            |                    |            |                    |            |     |     |       |       |      |                                                                                     |              |      |

\* Specified in multiples of 5mm

+ Specified in multiples of 25mm

Page Total 17.379 (in Kg)

Page 22 of 23

This Schedule complies with the requirements of BS8666-2005

info@dyndigi.com



### DYNDIGI Engineering Services

98, Swamy Nagar, Virupatchipuram  
Vellore, Tamil Nadu, India.

Telephone : +91 9566671043  
Web : www.dyndigi.com  
E-mail : info@dyndigi.com

Schedule ref:  Rev

Drawing No.: STARTERS-1 Rev

Drawing Title:

Project: Sample project  
Client: FEEL FREE CREATION  
Consultant: FFCM  
Main Contractor: --

Date Prepared: 07-Feb-2025 Date Revised:  
Prepared by: MRR Checked by: FFC

| MEMBER    | BAR MARK | TYPE AND SIZE | NO OF MBRS | NO OF BARS IN EACH | TOTAL NOS. | LENGTH OF EACH BAR | SHAPE CODE | A*  | B*     | C* | D* | E/R* | Shape Diagram | Weight in Kg | Rev. |
|-----------|----------|---------------|------------|--------------------|------------|--------------------|------------|-----|--------|----|----|------|---------------|--------------|------|
|           |          |               |            |                    |            | mm+                |            | mm  | mm     | mm | mm |      |               |              |      |
| COLUMN C7 | 129      | T16           | 1          | 9                  | 9          | 1875               | 11         | 450 | (1450) |    |    |      |               | 26.646       |      |
|           |          |               |            |                    |            |                    |            |     |        |    |    |      |               |              |      |
|           |          |               |            |                    |            |                    |            |     |        |    |    |      |               |              |      |
|           |          |               |            |                    |            |                    |            |     |        |    |    |      |               |              |      |
|           |          |               |            |                    |            |                    |            |     |        |    |    |      |               |              |      |
|           |          |               |            |                    |            |                    |            |     |        |    |    |      |               |              |      |
|           |          |               |            |                    |            |                    |            |     |        |    |    |      |               |              |      |
|           |          |               |            |                    |            |                    |            |     |        |    |    |      |               |              |      |
|           |          |               |            |                    |            |                    |            |     |        |    |    |      |               |              |      |

\* Specified in multiples of 5mm          + Specified in multiples of 25mm          Page Total 26.646 (in Kg)  
Page 23 of 23

This Schedule complies with the requirements of BS8666-2005

| SUMMARY OF REINFORCEMENT STEEL |    |       |       |       |       |     |     |     |       |
|--------------------------------|----|-------|-------|-------|-------|-----|-----|-----|-------|
| Size of bar                    | T8 | T10   | T12   | T16   | T20   | T25 | T32 | T40 | TOTAL |
| Weight(Ton)                    |    | 0.233 | 0.277 | 1.424 | 0.113 |     |     |     | 2.047 |